

# Placeholder Image

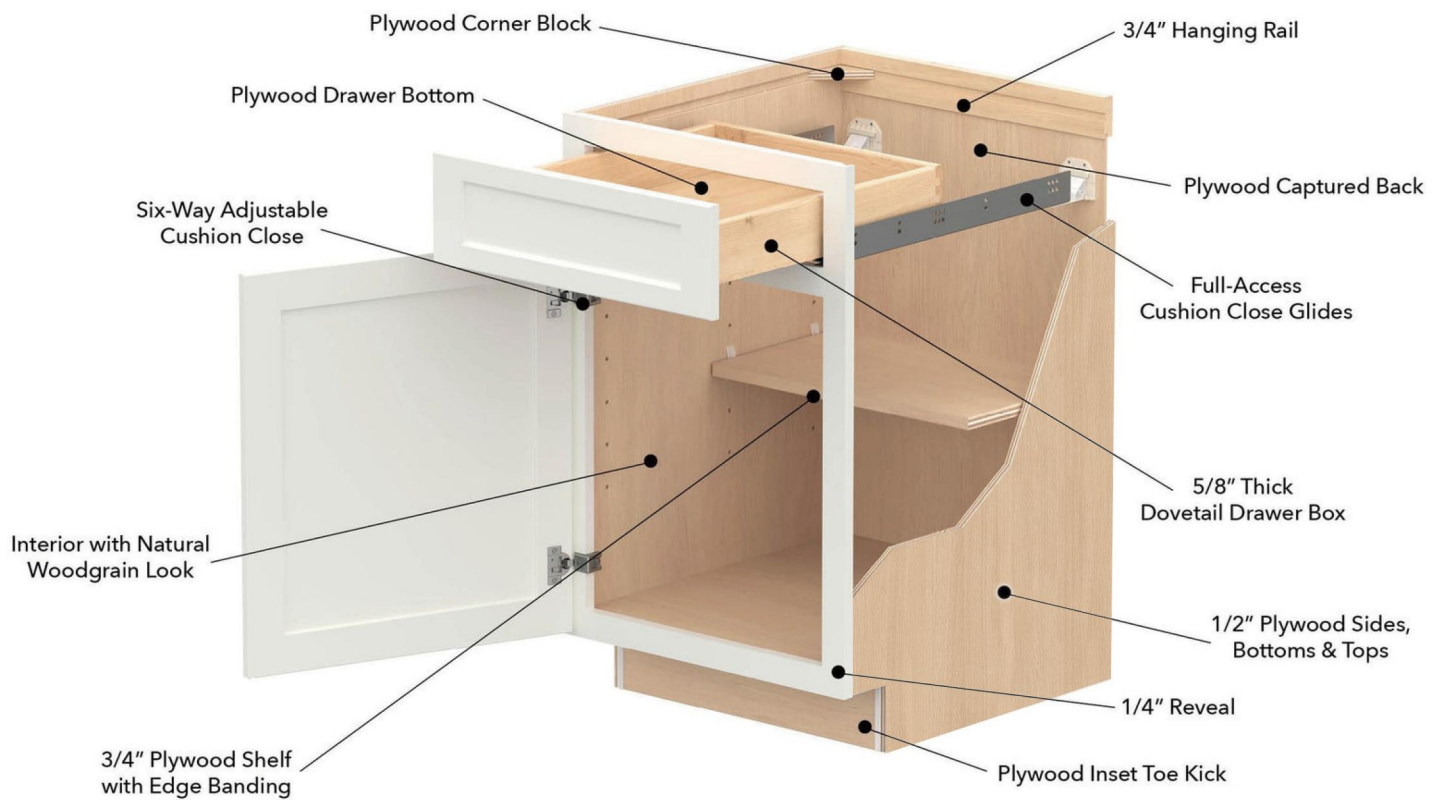
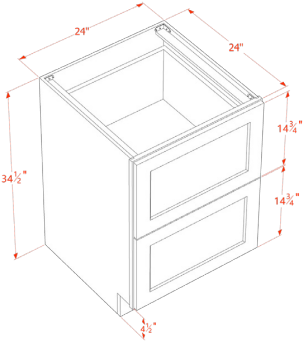
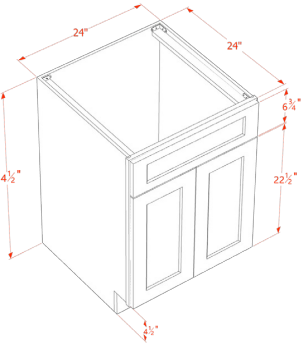
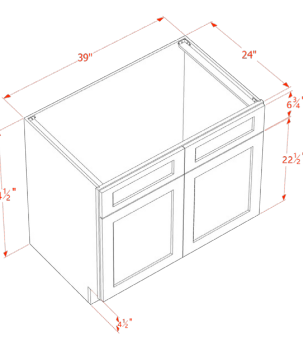
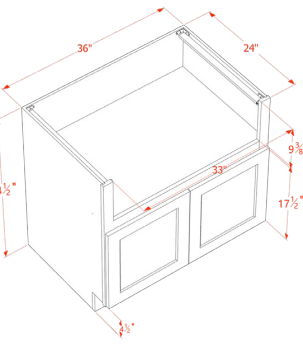
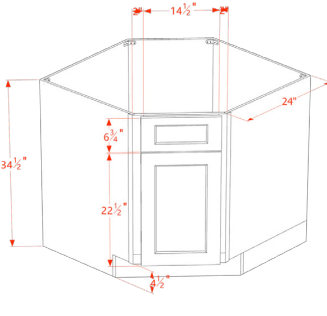
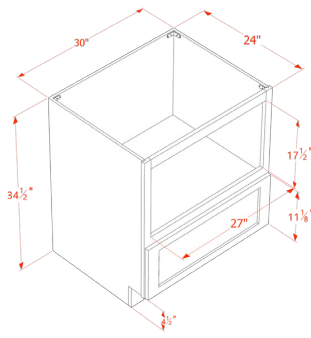
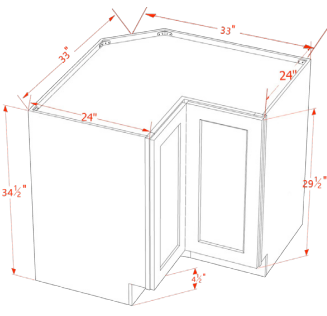
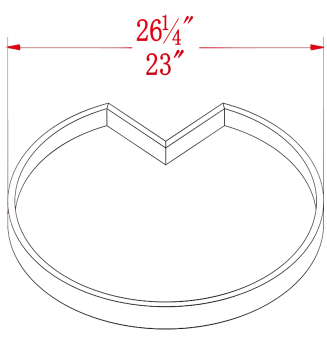

SINGLE DOOR BASE CABINET	ITEM	Description	L(in.)	W(in.)	H(in.)	Cubic Feet (ft <sup>3</sup> ) /CTN	lb/CTN
	<b>BF0924</b>	Standard Base - Full Height Door only - 09"W x 34-1/2"H x 24"D	36 1/4	25 1/2	4 1/4	2.32	30.86
	<b>B12</b>	Standard Base - 1 Door & 1 Drawer - 12"W x 34-1/2"H x 24"D	36 1/4	25 1/2	4 1/2	2.43	49.05
	<b>B15</b>	Standard Base - 1 Door & 1 Drawer - 15"W x 34-1/2"H x 24"D	36 1/4	25 1/2	4 1/2	2.43	50.71
	<b>B18</b>	Standard Base - 1 Door & 1 Drawer - 18"W x 34-1/2"H x 24"D	36 1/4	25 1/2	5	2.64	56.00
	<b>B21</b>	Standard Base - 1 Door & 1 Drawer - 21"W x 34-1/2"H x 24"D	36 1/4	25 1/2	5	2.64	60.96
DOUBLE DOOR BASE CABINET	ITEM	Description	L(in.)	W(in.)	H(in.)	Cubic Feet (ft <sup>3</sup> ) /CTN	lb/CTN
	<b>B24</b>	Standard Base - 2 Doors & 1 Drawer - 24"W x 34-1/2"H x 24"D	37 3/4	26 1/4	5	2.82	66.25
	<b>B27</b>	Standard Base - 2 Doors & 1 Drawer - 27"W x 34-1/2"H x 24"D	36 1/4	29 1/4	5	3.01	70.66
	<b>B30</b>	Standard Base - 2 Doors & 1 Drawer - 30"W x 34-1/2"H x 24"D	36 1/4	32	5	3.31	76.06
	<b>B33</b>	Standard Base - 2 Doors & 1 Drawer - 33"W x 34-1/2"H x 24"D	36 1/4	32	5	3.31	82.67
	<b>B36</b>	Standard Base - 2 Doors & 1 Drawer - 36"W x 34-1/2"H x 24"D	37 3/4	32	5	3.45	86.53
DOUBLE DOOR BASE CABINET	ITEM	Description	L(in.)	W(in.)	H(in.)	Cubic Feet (ft <sup>3</sup> ) /CTN	lb/CTN
	<b>B39</b>	Standard - 2 Door & 2 Drawer - 39"W X 34 1/2"H x 24"D	40 3/4	32	5	3.72	99.65
	<b>B42</b>	Standard - 2 Door & 2 Drawer - 42"W X 34 1/2"H x 24"D	43 3/4	32	5	3.99	104.28
THREE DRAWERS BASE CABINET	ITEM	Description	L(in.)	W(in.)	H(in.)	Cubic Feet (ft <sup>3</sup> ) /CTN	lb/CTN
	<b>DB12</b>	Drawer Base - 3 Drawer 12"W x 34 1/2"H x 24"D	36 1/4	25 1/2	5 3/4	3.06	75.73
	<b>DB15</b>	Drawer Base - 3 Drawer 15"W x 34 1/2"H x 24"D	36 1/4	25 1/2	5 3/4	3.06	81.13
	<b>DB18</b>	Drawer Base - 3 Drawer 18"W x 34 1/2"H x 24"D	36 1/4	25 1/2	5 3/4	3.06	87.74
	<b>DB21</b>	Drawer Base - 3 Drawer 21"W x 34 1/2"H x 24"D	37 3/4	26 1/4	5 3/4	3.27	92.59
	<b>DB24</b>	Drawer Base - 3 Drawer 24"W x 34 1/2"H x 24"D	37 3/4	29	6 1/2	4.11	101.96
	<b>DB27</b>	Drawer Base - 3 Drawer 27"W x 34 1/2"H x 24"D	37 3/4	31	6 1/2	4.39	109.02
	<b>DB30</b>	Drawer Base - 3 Drawer 30"W x 34 1/2"H x 24"D	36 1/4	32	4.37	4.37	114.42
	<b>DB33</b>	Drawer Base - 3 Drawer 33"W x 34 1/2"H x 24"D	36 1/4	32	4.37	4.37	120.48
<b>DB36</b>	Drawer Base - 3 Drawer 36"W x 34 1/2"H x 24"D	37 3/4	32	6 1/2	4.56	128.64	

TWO DRAWERS BASE CABINET		ITEM	Description	L(in.)	W(in.)	H(in.)	Cubic Feet (ft <sup>3</sup> ) /CTN	lb/CTN
	<b>DB24-2</b>	Drawer Base - 2 Drawer - 24"W x 34-1/2"H x 24"D	37 3/4	29	5 3/4	3.61	102.63	
	<b>DB30-2</b>	Drawer Base - 2 Drawer - 30"W x 34-1/2"H x 24"D	36 1/4	32	5 3/4	3.84	112.77	
SINK BASE CABINET		ITEM	Description	L(in.)	W(in.)	H(in.)	Cubic Feet (ft <sup>3</sup> ) /CTN	lb/CTN
	<b>SB24</b>	Sink Base - 2 Door & 1 False Drawer - 24"W x 34-1/2"H x 24"D	36 1/4	26 1/4	4 1/4	2.27	48.94	
	<b>SB30</b>	Sink Base - 2 Door & 1 False Drawer - 30"W x 34-1/2"H x 24"D	36 1/4	32	4 1/4	2.78	54.67	
	<b>SB33</b>	Sink Base - 2 Door & 1 False Drawer - 33"W x 34-1/2"H x 24"D	36 1/4	32	4 1/4	2.78	58.42	
	<b>SB36</b>	Sink Base - 2 Door & 1 False Drawer - 36"W x 34-1/2"H x 24"D	36 3/4	32	4 1/4	2.90	63.71	
SINK BASE CABINET		ITEM	Description	L(in.)	W(in.)	H(in.)	Cubic Feet (ft <sup>3</sup> ) /CTN	lb/CTN
	<b>SB39</b>	Sink Base - 2 Door & 2 False Drawer - 39"W x 34-1/2"H x 24"D	40 3/4	32	4 1/4	3.13	65.48	
	<b>SB42</b>	Sink Base - 2 Door & 2 False Drawer - 42"W x 34-1/2"H x 24"D	43 3/4	32	4 1/4	3.35	68.89	
	<b>FS36</b>	Sink Base - Farmhouse w/ 2 Door - 36"W x 34-1/2"H x 24"D	37 3/4	32 1/4	5	3.60	69.23	

DIAGONAL SINK BASE	ITEM	Description	L(in.)	W(in.)	H(in.)	Cubic Feet (ft <sup>3</sup> ) /CTN	lb/CTN
	<b>DSB36</b>	Corner Sink Base - Diagonal w/1 Door & False Drawer - 36"W x 34-1/2"H x 24"D	37	37 1/2	5 3/4	4.60	129.96
	<b>DSB42</b>	Corner Sink Base - Diagonal w/1 Door & False Drawer - 42"W x 34-1/2"H x 24"D	43 1/2	44	4 3/4	5.22	157.63
BASE MICROWAVE CABINET	ITEM	Description	L(in.)	W(in.)	H(in.)	Cubic Feet (ft <sup>3</sup> ) /CTN	lb/CTN
	<b>BMC30</b>	Appliance Base - Microwave Shelf w/ 1 Drawer - 30"W x 34-1/2"H x 24"D	36 1/4	32	5	3.44	78.15
LAZY SUSAN BASE CORNER CABINET	ITEM	Description	L(in.)	W(in.)	H(in.)	Cubic Feet (ft <sup>3</sup> ) /CTN	lb/CTN
	<b>LSB33</b>	Corner Base - Lazy Susan w/2 Door - 33"W x 34-1/2"H	36 1/4	34 3/4	5	3.74	80.36
	<b>LSB36</b>	Corner Base - Lazy Susan w/2 Door - 36"W x 34-1/2"H	37 1/2	38	5	4.23	68.89
	<b>LST33</b>	Lazy Susan 33" Wood Basket (w/Turntable)	24 1/2	25	7 3/4	2.80	19.40
	<b>LST36</b>	Lazy Susan 36" Wood Basket (w/Turntable)	27 3/4	28 1/4	7 3/4	3.56	22.27

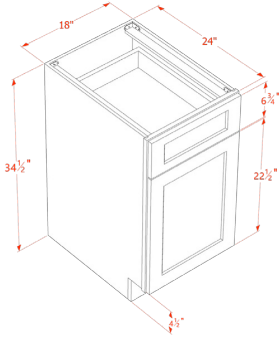
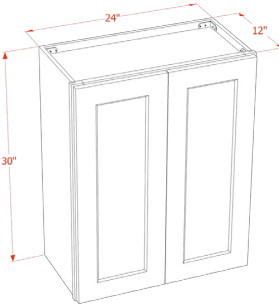
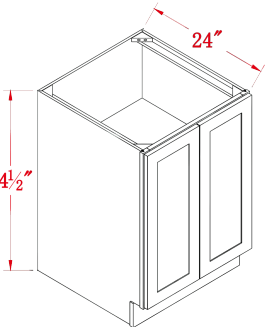
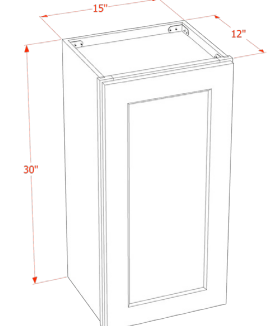

<b>BLIND BASE CORNER CABINET</b>	<b>ITEM</b>	<b>Description</b>	<b>L(in.)</b>	<b>W(in.)</b>	<b>H(in.)</b>	<b>Cubic Feet (ft<sup>3</sup>) /CTN</b>	<b>lb/CTN</b>
	<b>BBC39/42</b>	Blind Base Corner - Blind w/1 Door & 1 Drawer - 39"W x 34-1/2"H x 24"D	40 3/4	32	4 3/4	3.57	84.66
	<b>BBC42/45</b>	Blind Base Corner - Blind w/1 Door & 1 Drawer - 42"W x 34-1/2"H x 24"D	43 3/4	32	4 3/4	3.83	86.86
<b>24" DEEP FULL DOOR BASE</b>							
	<b>BF09-PO</b>	Pull Out Base - Spice Rack w/Drawer - 09"W x 34-1/2"H x 24"D	37 1/4	27 3/4	9 3/4	5.88	53.79
<b>BASE END SHELF CABINET</b>							
	<b>BES12L</b>	Base End Shelf - End Shelf w/ 4 Shelf (Left Open) - 12"W x 34-1/2"H x 24"D	36 1/4	26 1/4	3 1/4	1.84	38.58
	<b>BES12R</b>	Base End Shelf - End Shelf w/ 4 Shelf (Right Open) - 12"W x 34-1/2"H x 24"D	36 1/4	26 1/4	3 1/4	1.84	38.58
<b>BASE END CORNER</b>							
	<b>BEC24</b>	Base End Corner - Angle End w/ 2 Full Heigh Door - 24"W x 34-1/2"H x 24"D	36 1/4	32 1/4	4 3/4	3.19	47.40

BASE WASTE BASKET CABINET	ITEM	Description	L(in.)	W(in.)	H(in.)	Cubic Feet (ft <sup>3</sup> ) /CTN	lb/CTN
	<b>B18TR</b>	Pull Out Base - Trash Pull Out (incl. 2 Basket) w/ 1 Drawer - 18"W x 34-1/2"H x 24"D	36 1/4	25 1/2	5 1/2	2.96	72.64
	<b>Waste Basket included</b>						
24" DEEP FULL DOOR BASE CABINET	ITEM	Description	L(in.)	W(in.)	H(in.)	Cubic Feet (ft <sup>3</sup> ) /CTN	lb/CTN
	<b>BF1224</b>	Full Height Base - 1 Door & 1 Shelf - 12"W x 34 1/2"H x 24"D	36 1/4	25 1/2	4 1/4	2.32	38.69
	<b>BF1524</b>	Full Height Base - 1 Door & 1 Shelf - 15"W x 34 1/2"H x 24"D	36 1/4	25 1/2	4 1/4	2.32	42.77
	<b>BF1824</b>	Full Height Base - 1 Door & 1 Shelf - 18"W x 34 1/2"H x 24"D	36 1/4	25 1/2	4 1/4	2.32	45.75
	<b>BF2124</b>	Full Height Base - 1 Door & 1 Shelf - 21"W x 34 1/2"H x 24"D	36 1/4	25 1/2	4 1/4	2.32	48.83
24" DEEP FULL DOOR BASE CABINET	ITEM	Description	L(in.)	W(in.)	H(in.)	Cubic Feet (ft <sup>3</sup> ) /CTN	lb/CTN
	<b>BF2424</b>	Full Height Base - 2 Door & 1 Shelf - 24"W x 34 1/2"H x 24"D	36 1/4	25 1/2	4 1/4	2.32	54.78
	<b>BF2724</b>	Full Height Base - 2 Door & 1 Shelf - 27"W x 34 1/2"H x 24"D	36 1/4	28 1/4	4 1/4	2.56	57.43
	<b>BF3024</b>	Full Height Base - 2 Door & 1 Shelf - 30"W x 34 1/2"H x 24"D	36 1/4	32	4 1/4	2.91	61.51
	<b>BF3224</b>	Full Height Base - 2 Door & 1 Shelf - 32"W x 34 1/2"H x 24"D	36 1/4	32	4 1/4	2.91	65.15
	<b>BF3623</b>	Full Height Base - 2 Door & 1 Shelf - 36"W x 34 1/2"H x 24"D	37 3/4	32	4 1/4	3.04	68.23
30" HIGH 12" DEEP WALL CABINET	ITEM	Description	L(in.)	W(in.)	H(in.)	Cubic Feet (ft <sup>3</sup> ) /CTN	lb/CTN
	<b>W0930</b>	Standard Wall - 1 Door & 2 Shelf - 09"W x 30"H x 12"D	31 3/4	14 1/4	4 3/4	1.23	21.61
	<b>W1230</b>	Standard Wall - 1 Door & 2 Shelf - 12"W x 30"H x 12"D	31 3/4	14 1/4	4 3/4	1.23	24.91
	<b>W1530</b>	Standard Wall - 1 Door & 2 Shelf - 15"W x 30"H x 12"D	31 3/4	17 1/4	4 3/4	1.48	28.33
	<b>W1830</b>	Standard Wall - 1 Door & 2 Shelf - 18"W x 30"H x 12"D	31 3/4	20 1/4	4 3/4	1.76	32.74
	<b>W2130</b>	Standard Wall - 1 Door & 2 Shelf - 21"W x 30"H x 12"D	31 3/4	23 1/4	4 3/4	2.01	34.83

30" HIGH 12" DEEP WALL CABINET	ITEM	Description	L(in.)	W(in.)	H(in.)	Cubic Feet (ft <sup>3</sup> ) /CTN	lb/CTN
	<b>W2430</b>	Standard Wall - 2 Door & 2 Shelf - 24"W x 30"H x 12"D	31 3/4	26 1/4	4 1/4	2.08	41.23
	<b>W2730</b>	Standard Wall - 2 Door & 2 Shelf - 27"W x 30"H x 12"D	31 3/4	29 1/4	4 1/4	2.31	44.42
	<b>W3030</b>	Standard Wall - 2 Door & 2 Shelf - 30"W x 30"H x 12"D	31 3/4	32	4 1/4	2.55	48.06
	<b>W3330</b>	Standard Wall - 2 Door & 2 Shelf - 33"W x 30"H x 12"D	34 3/4	32	4 1/4	2.80	52.25
	<b>W3630</b>	Standard Wall - 2 Door & 2 Shelf - 36"W x 30"H x 12"D	37 3/4	32	4 1/4	3.04	56.88
30" HIGH 12" DEEP WALL CABINET	ITEM	Description	L(in.)	W(in.)	H(in.)	Cubic Feet (ft <sup>3</sup> ) /CTN	lb/CTN
	<b>W3930</b>	Standard Base - 2 Doors & 1 Drawer - 39"W x 34-1/2"H x 24"D	37 3/4	26 1/4	5	2.82	66.25
	<b>W4230</b>	Standard Base - 2 Doors & 1 Drawer - 42"W x 34-1/2"H x 24"D	36 1/4	29 1/4	5	3.01	70.66
36" HIGH 12" DEEP WALL CABINET	ITEM	Description	L(in.)	W(in.)	H(in.)	Cubic Feet (ft <sup>3</sup> ) /CTN	lb/CTN
	<b>W0936</b>	Standard Wall - 1 Door & 2 Shelf - 09"W x 36"H x 12"D	37 3/4	14 1/4	4 3/4	1.46	25.24
	<b>W1236</b>	Standard Wall - 1 Door & 2 Shelf - 12"W x 36"H x 12"D	37 3/4	14 1/4	4 3/4	1.46	28.66
	<b>W1536</b>	Standard Wall - 1 Door & 2 Shelf - 15"W x 36"H x 12"D	37 3/4	17 1/4	4 3/4	1.77	33.29
	<b>W1836</b>	Standard Wall - 1 Door & 2 Shelf - 18"W x 36"H x 12"D	37 3/4	20 1/4	4 3/4	2.10	37.26
	<b>W2136</b>	Standard Wall - 1 Door & 2 Shelf - 21"W x 36"H x 12"D	37 3/4	23 1/4	4 3/4	2.40	41.34
36" HIGH 12" DEEP WALL CABINET	ITEM	Description	L(in.)	W(in.)	H(in.)	Cubic Feet (ft <sup>3</sup> ) /CTN	lb/CTN
	<b>W2436</b>	Standard Wall - 2 Door & 2 Shelf - 24"W x 36"H x 12"D	37 3/4	26 1/4	4 1/4	2.48	48.39
	<b>W2736</b>	Standard Wall - 2 Door & 2 Shelf - 27"W x 36"H x 12"D	37 3/4	29 1/4	4 1/4	2.76	53.35
	<b>W3036</b>	Standard Wall - 2 Door & 2 Shelf - 30"W x 36"H x 12"D	37 3/4	32	4 1/4	3.04	55.78
	<b>W3336</b>	Standard Wall - 2 Door & 2 Shelf - 33"W x 36"H x 12"D	37 3/4	35 1/4	4 1/4	3.34	59.86
	<b>W3636</b>	Standard Wall - 2 Door & 2 Shelf - 36"W x 36"H x 12"D	37 3/4	38 1/4	4 1/4	3.62	61.51

<b>36" HIGH 12" DEEP WALL CABINET</b>	<b>ITEM</b>	<b>Description</b>	<b>L(in.)</b>	<b>W(in.)</b>	<b>H(in.)</b>	<b>Cubic Feet (ft<sup>3</sup>) /CTN</b>	<b>lb/CTN</b>
	<b>W3936</b>	Standard Wall - 2 Door & 2 Shelf - 39"W x 36"H x 12"D	40 3/4	38 1/4	4 1/4	3.90	65.04
	<b>W4236</b>	Standard Wall - 2 Door & 2 Shelf - 42"W x 36"H x 12"D	43 3/4	38 1/4	4 1/4	4.18	75.62
<b>42" HIGH 12" DEEP WALL CABINET</b>							
	<b>W0942</b>	Standard Wall - 1 Door & 3 Shelf - 09"W x 42"H x 12"D	43 3/4	14 1/4	4 3/4	1.69	29.76
	<b>W1242</b>	Standard Wall - 1 Door & 3 Shelf - 12"W x 42"H x 12"D	43 3/4	14 1/4	4 3/4	1.69	33.29
	<b>W1542</b>	Standard Wall - 1 Door & 3 Shelf - 15"W x 42"H x 12"D	43 3/4	17 1/4	4 3/4	2.05	38.69
	<b>W1842</b>	Standard Wall - 1 Door & 3 Shelf - 18"W x 42"H x 12"D	43 3/4	20 1/4	4 3/4	2.42	44.53
	<b>W2142</b>	Standard Wall - 1 Door & 3 Shelf - 21"W x 42"H x 12"D	43 3/4	23 1/4	4 3/4	2.78	46.19
<b>42" HIGH 12" DEEP WALL CABINET</b>							
	<b>W2442</b>	Standard Wall - 2 Door & 3 Shelf - 24"W x 42"H x 12"D	43 3/4	26 1/4	4 1/4	2.87	54.90
	<b>W2742</b>	Standard Wall - 2 Door & 3 Shelf - 27"W x 42"H x 12"D	43 3/4	29 1/4	4 1/4	3.19	59.86
	<b>W3042</b>	Standard Wall - 2 Door & 3 Shelf - 30"W x 42"H x 12"D	43 3/4	32	4 1/4	3.51	65.15
	<b>W3342</b>	Standard Wall - 2 Door & 3 Shelf - 33"W x 42"H x 12"D	43 3/4	35 1/4	4 1/4	3.86	71.32
	<b>W3642</b>	Standard Wall - 2 Door & 3 Shelf - 36"W x 42"H x 12"D	43 3/4	38 1/4	4 1/4	4.18	74.54
<b>42" HIGH 12" DEEP WALL CABINET</b>							
	<b>W3942</b>	Standard Wall - 2 Door & 3 Shelf - 39"W x 42"H x 12"D	43 3/4	41 1/4	4 1/4	4.51	80.80
	<b>W4242</b>	Standard Wall - 2 Door & 3 Shelf - 42"W x 42"H x 12"D	43 3/4	44	4 1/4	4.83	87.08

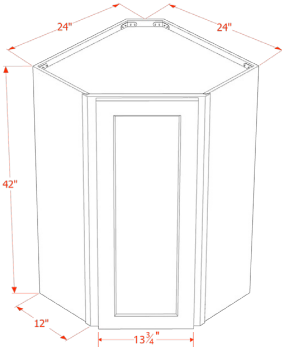
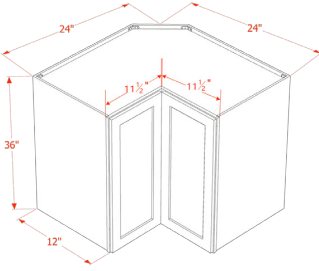
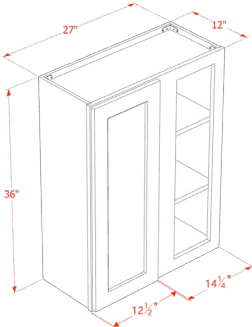
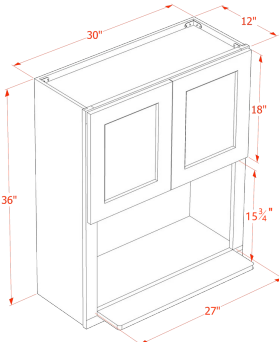
WALL DIAGONAL CORNER CABINET	ITEM	Description	L(in.)	W(in.)	H(in.)	Cubic Feet (ft <sup>3</sup> ) /CTN	lb/CTN
	<b>WDC2430</b>	Corner Wall - Diagonal w/ 1 Door & 2 Shelf - 24"W x 30"H x 12"D	31 3/4	25 3/4	6	2.79	54.90
	<b>WDC2436</b>	Corner Wall - Diagonal w/ 1 Door & 2 Shelf - 24"W x 36"H x 12"D	37 3/4	25 3/4	6 3/4	3.77	65.04
	<b>WDC2442</b>	Corner Wall - Diagonal w/ 1 Door & 3 Shelf - 24"W x 42"H x 12"D	43 3/4	25 3/4	6	3.85	72.09
WALL PIE CUT CORNER CABINET	ITEM	Description	L(in.)	W(in.)	H(in.)	Cubic Feet (ft <sup>3</sup> ) /CTN	lb/CTN
	<b>WPC2430</b>	Corner Wall - Pie-cut w/ 1 Door & 2 Shelf - 24"W x 30"H x 12"D	35 1/2	27	4	2.18	52.03
	<b>WPC2436</b>	Corner Wall - Pie-cut w/ 1 Door & 2 Shelf - 24"W x 36"H x 12"D	37 3/4	27	4 1/2	2.67	60.19
	<b>WPC2442</b>	Corner Wall - Pie-cut w/ 1 Door & 3 Shelf - 24"W x 42"H x 12"D	44	27	4 1/2	3.10	73.30
WALL BLIND CORNER	ITEM	Description	L(in.)	W(in.)	H(in.)	Cubic Feet (ft <sup>3</sup> ) /CTN	lb/CTN
	<b>WBC2730</b>	Corner Wall - Blind w/ 1 Door & 2 Shelf - 27"W x 30"H x 12"D	31 3/4	29 1/4	4 1/4	2.31	45.19
	<b>WBC2736</b>	Corner Wall - Blind w/ 1 Door & 2 Shelf - 27"W x 36"H x 12"D	37 3/4	29 1/4	4 1/4	2.76	50.71
	<b>WBC2742</b>	Corner Wall - Blind w/ 1 Door & 3 Shelf - 27"W x 42"H x 12"D	43 3/4	29 1/4	4 1/4	3.19	61.29
WALL MICROWAVE	ITEM	Description	L(in.)	W(in.)	H(in.)	Cubic Feet (ft <sup>3</sup> ) /CTN	lb/CTN
	<b>WM3030</b>	Appliance Wall - Microwave Shelf w/ 2 Door - 30"W x 30"H x 12"D	31 3/4	32	4 1/4	2.55	45.19
	<b>WM3036</b>	Appliance Wall - Microwave Shelf w/ 2 Door - 30"W x 36"H x 12"D	37 1/2	32	4 1/4	3.02	48.50
	<b>WM3042</b>	Appliance Wall - Microwave Shelf w/ 2 Door & 1 Shelf - 30"W x 42"H x 12"D	43 3/4	32	4 1/4	3.51	60.30

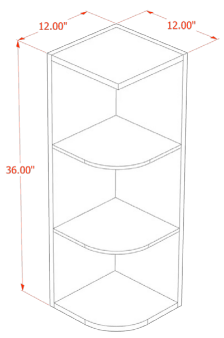
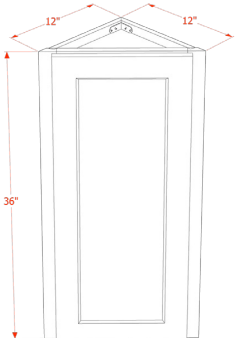
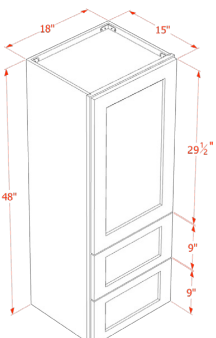
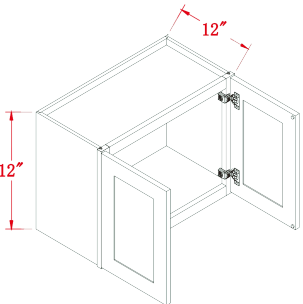
<b>WALL END SHELF</b>	<b>ITEM</b>	<b>Description</b>	<b>L(in.)</b>	<b>W(in.)</b>	<b>H(in.)</b>	<b>Cubic Feet (ft<sup>3</sup>) /CTN</b>	<b>lb/CTN</b>
	<b>OE1230</b>	Corner Wall - End Shelf w/ 4 Shelf - 12"W x 30"H x 12"D	31 3/4	14 1/4	3 1/2	0.92	22.60
	<b>OE1236</b>	Corner Wall - End Shelf w/ 4 Shelf - 12"W x 36"H x 12"D	37 3/4	14 1/4	3 1/2	1.10	25.02
	<b>OE1242</b>	Corner Wall - End Shelf w/ 5 Shelf - 12"W x 42"H x 12"D	43 3/4	14 1/4	3 1/2	1.27	27.89
<b>WALL ANGLE END CABINET</b>	<b>ITEM</b>	<b>Description</b>	<b>L(in.)</b>	<b>W(in.)</b>	<b>H(in.)</b>	<b>Cubic Feet (ft<sup>3</sup>) /CTN</b>	<b>lb/CTN</b>
	<b>WAE1230</b>	Corner Wall - Angle End w/ 1 Door & 2 Shelf - 12"W x 30"H x 12"D	32	19 1/2	4	1.42	18.96
	<b>WAE1236</b>	Corner Wall - Angle End w/ 1 Door & 2 Shelf - 12"W x 36"H x 12"D	38	19 1/2	4	1.69	22.93
	<b>WAE1242</b>	Corner Wall - Angle End w/ 1 Door & 3 Shelf - 12"W x 42"H x 12"D	44 1/4	19 1/2	4	1.97	25.04
<b>WALL WITH DRAWERS CABINET</b>	<b>ITEM</b>	<b>Description</b>	<b>L(in.)</b>	<b>W(in.)</b>	<b>H(in.)</b>	<b>Cubic Feet (ft<sup>3</sup>) /CTN</b>	<b>lb/CTN</b>
	<b>WD1848</b>	Drawer Wall - 1 Door & 2 Drawer - 18"W x 48"H x 15"D	49 3/4	20 1/2	4 3/4	2.80	77.16
	<b>WD1854</b>	Drawer Wall - 1 Door & 2 Drawer - 18"W x 54"H x 15"D	55 3/4	20 1/2	5	3.40	85.98
	<b>WD1860</b>	Drawer Wall - 1 Door & 2 Drawer - 18"W x 60"H x 15"D	62 1/2	20 1/2	5	3.81	93.70
<b>12" HIGH 12" DEEP BRIDGE CABINET</b>	<b>ITEM</b>	<b>Description</b>	<b>L(in.)</b>	<b>W(in.)</b>	<b>H(in.)</b>	<b>Cubic Feet (ft<sup>3</sup>) /CTN</b>	<b>lb/CTN</b>
	<b>W3012</b>	Standard Wall - 2 Door - 30"W x 12"H x 12"D	32 3/4	14 3/4	4 1/4	1.16	22.82
	<b>W3312</b>	Standard Wall - 2 Door - 33"W x 12"H x 12"D	35 1/4	14 3/4	4 1/4	1.24	23.92
	<b>W3612</b>	Standard Wall - 2 Door - 36"W x 12"H x 12"D	38	14 3/4	4 1/4	1.34	26.01
	<b>W3912</b>	Standard Wall - 2 Door - 39"W x 12"H x 12"D	41 1/4	14 1/4	4 1/4	1.39	27.89

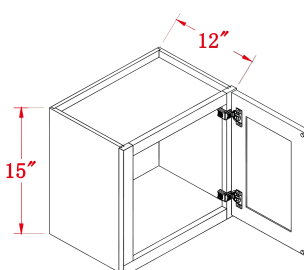
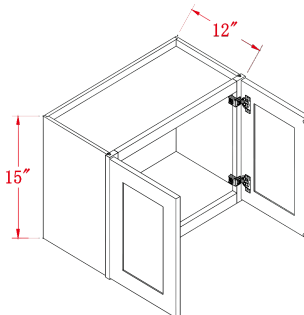
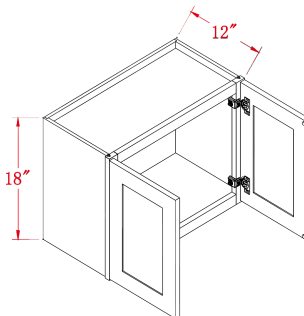
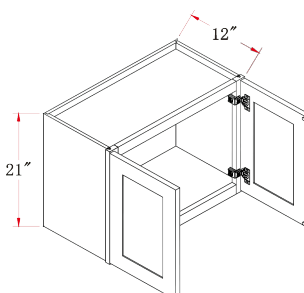
15" HIGH 12" DEEP WALL BRIDGE CABINET	ITEM	Description	L(in.)	W(in.)	H(in.)	Cubic Feet (ft <sup>3</sup> )/CTN	lb/CTN
	<b>W1215</b>	Standard Wall - 1 Door - 12"W x 15"H x 12"D	17 1/4	14 3/4	4 3/4	0.69	12.90
	<b>W1515</b>	Standard Wall - 1 Door - 15"W x 15"H x 12"D	17 1/4	17 1/2	4 3/4	0.82	15.43
	<b>W1815</b>	Standard Wall - 1 Door - 18"W x 15"H x 12"D	20	17 1/2	4 3/4	0.95	17.31
	<b>W2115</b>	Standard Wall - 1 Door - 21"W x 15"H x 12"D	22 3/4	17 1/2	6 3/4	1.55	20.28
15" HIGH 12" DEEP WALL BRIDGE CABINET	ITEM	Description	L(in.)	W(in.)	H(in.)	Cubic Feet (ft <sup>3</sup> )/CTN	lb/CTN
	<b>W2415</b>	Standard Wall - 2 Door - 24"W x 15"H x 12"D	25 3/4	17 1/2	4 1/4	1.08	22.49
	<b>W2715</b>	Standard Wall - 2 Door - 27"W x 15"H x 12"D	29	17 1/2	4 1/4	1.21	24.03
	<b>W3015</b>	Standard Wall - 2 Door - 30"W x 15"H x 12"D	31 3/4	17 1/2	4 1/4	1.33	24.91
	<b>W3315</b>	Standard Wall - 2 Door - 33"W x 15"H x 12"D	35 1/4	17 1/2	4 1/4	1.48	27.12
	<b>W3615</b>	Standard Wall - 2 Door - 36"W x 15"H x 12"D	38	17 1/2	4 1/4	1.59	30.31
	<b>W3915</b>	Standard Wall - 2 Door - 39"W x 15"H x 12"D	41 1/4	17 1/4	4 1/4	1.69	31.64
18" HIGH 12" DEEP WALL BRIDGE CABINET	ITEM	Description	L(in.)	W(in.)	H(in.)	Cubic Feet (ft <sup>3</sup> )/CTN	lb/CTN
	<b>W2418</b>	Standard Wall - 2 Door - 24"W x 18"H x 12"D	25 3/4	20 1/4	4 1/4	1.25	24.69
	<b>W3018</b>	Standard Wall - 2 Door - 30"W x 18"H x 12"D	32	20 1/4	4 1/4	1.56	28.88
	<b>W3318</b>	Standard Wall - 2 Door - 33"W x 18"H x 12"D	35 1/4	20 1/4	4 1/4	1.71	30.53
	<b>W3618</b>	Standard Wall - 2 Door - 36"W x 18"H x 12"D	38	20 1/4	4 1/4	1.84	33.40
	<b>W3918</b>	Standard Wall - 2 Door - 39"W x 18"H x 12"D	41 1/4	20 1/4	4 1/4	2.00	36.16
21" HIGH 12" DEEP WALL BRIDGE CABINET	ITEM	Description	L(in.)	W(in.)	H(in.)	Cubic Feet (ft <sup>3</sup> )/CTN	lb/CTN
	<b>W3021</b>	Standard Wall - 2 Door - 30"W x 21"H x 12"D	31 3/4	23 1/2	4 1/4	1.78	35.27
	<b>W3321</b>	Standard Wall - 2 Door - 33"W x 21"H x 12"D	35 1/4	23 1/2	4 1/4	1.97	38.36
	<b>W3621</b>	Standard Wall - 2 Door - 36"W x 21"H x 12"D	38	23 1/2	4 1/2	2.33	41.34
	<b>W3921</b>	Standard Wall - 2 Door - 39"W x 21"H x 12"D	41 1/4	23 1/2	4 1/2	2.53	47.95

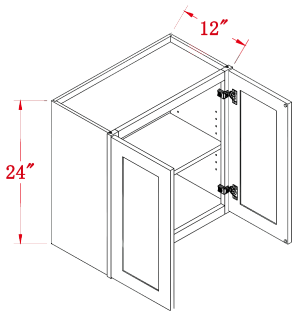
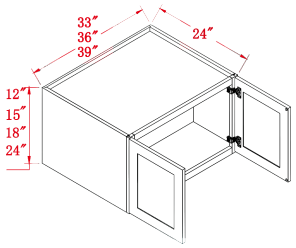
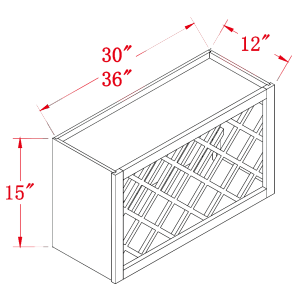
24" HIGH 12" DEEP WALL BRIDGE CABINET	ITEM	Description	L(in.)	W(in.)	H(in.)	Cubic Feet (ft <sup>3</sup> ) /CTN	lb/CTN
	<b>W2424</b>	Standard Wall - 2 Door & 1 Shelf - 24"W x 24"H x 12"D	25 3/4	26 1/4	4 1/2	1.77	33.18
	<b>W3024</b>	Standard Wall - 2 Door & 1 Shelf - 30"W x 24"H x 12"D	31 3/4	26 1/4	4 1/2	2.17	39.46
	<b>W3324</b>	Standard Wall - 2 Door & 1 Shelf - 33"W x 24"H x 12"D	35 1/4	26 1/4	4 1/2	2.42	43.54
	<b>W3624</b>	Standard Wall - 2 Door & 1 Shelf - 36"W x 24"H x 12"D	38	26 1/4	4 1/2	2.61	44.42
	<b>W3924</b>	Standard Wall - 2 Door & 1 Shelf - 39"W x 24"H x 12"D	41 1/4	26 1/4	4 1/2	2.82	49.27
24" DEEP BRIDGE WALL CABINET	ITEM	Description	L(in.)	W(in.)	H(in.)	Cubic Feet (ft <sup>3</sup> ) /CTN	lb/CTN
	<b>W331224</b>	Standard Wall - 2 Door - 33"W x 12"H x 24"D	34 3/4	26 1/4	4 1/4	2.29	33.07
	<b>W331524</b>	Standard Wall - 2 Door - 33"W x 15"H x 24"D	34 3/4	26 1/4	4 1/4	2.29	37.48
	<b>W331824</b>	Standard Wall - 2 Door - 33"W x 18"H x 24"D	34 3/4	26 1/4	4 1/4	2.29	42.00
	<b>W332424</b>	Standard Wall - 2 Door & 1 Shelf - 33"W x 24"H x 24"D	34 3/4	26 1/4	5 3/4	3.01	57.32
	<b>W361224</b>	Standard Wall - 2 Door - 36"W x 12"H x 24"D	38	26 1/4	4 1/4	2.49	39.57
	<b>W361524</b>	Standard Wall - 2 Door - 36"W x 15"H x 24"D	38	26 1/4	4 1/4	2.49	43.87
	<b>W361824</b>	Standard Wall - 2 Door - 36"W x 18"H x 24"D	38	26 1/4	4 1/4	2.49	48.61
	<b>W362124</b>	Standard Wall - 2 Door & 1 Shelf - 36"W x 21"H x 24"D	38	26 1/4	5 1/2	3.17	43.87
	<b>W362424</b>	Standard Wall - 2 Door & 1 Shelf - 36"W x 24"H x 24"D	38	26 1/4	5 3/4	3.29	64.60
	<b>W391224</b>	Standard Wall - 2 Door - 39"W x 12"H x 24"D	41 1/4	26 1/4	4 1/4	2.70	42.99
	<b>W391524</b>	Standard Wall - 2 Door - 39"W x 15"H x 24"D	41 1/4	26 1/4	4 1/4	2.70	47.40
	<b>W391824</b>	Standard Wall - 2 Door - 39"W x 18"H x 24"D	41 1/4	26 1/4	4 1/4	2.70	50.71
	<b>W392424</b>	Standard Wall - 2 Door & 1 Shelf - 39"W x 24"H x 24"D	41 1/4	26 1/4	5 3/4	3.56	70.77
	WINE RACK	ITEM	Description	L(in.)	W(in.)	H(in.)	Cubic Feet (ft <sup>3</sup> ) /CTN
	<b>WR3015</b>	Wall - Wine Rack - 30"W x 15"H x 12"D	31 3/4	17 1/4	5	1.61	26.46
	<b>WR3615</b>	Wall - Wine Rack - 36"W x 15"H x 12"D	37 3/4	17 1/4	5	1.92	31.97

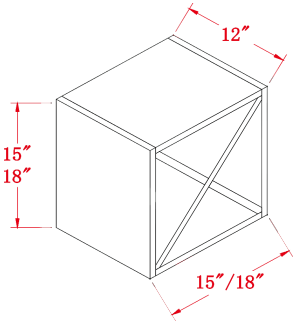
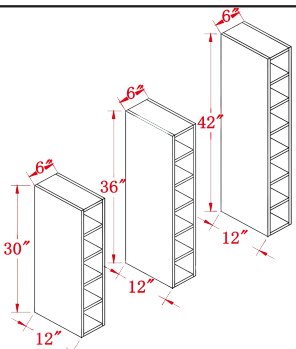
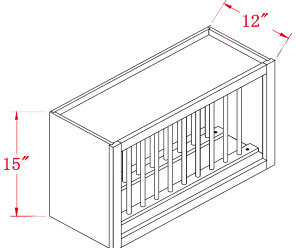
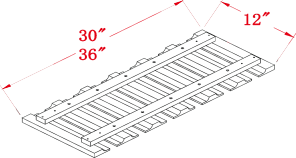

WINE RACK	ITEM	Description	L(in.)	W(in.)	H(in.)	Cubic Feet (ft <sup>3</sup> )/CTN	lb/CTN
	<b>WR1515</b>	Wall - Wine Rack - Incl. Shelf - 15"W x 15"H x 12"D	20 3/4	16 1/4	5 1/2	1.08	26.68
	<b>WR1818</b>	Wall - Wine Rack - Incl. Shelf - 18"W x 15"H x 12"D	25 1/4	18 3/4	5 1/2	1.50	32.63
WINE CUBE	ITEM	Description	L(in.)	W(in.)	H(in.)	Cubic Feet (ft <sup>3</sup> )/CTN	lb/CTN
	<b>WC0630</b>	Wall - Wine Cube - 06"W x 30"H x 12"D	32	14 1/2	3	0.80	20.50
	<b>WC0636</b>	Wall - Wine Cube - 06"W x 36"H x 12"D	38	14 1/2	3	0.95	23.92
	<b>WC0642</b>	Wall - Wine Cube - 06"W x 42"H x 12"D	43 3/4	14 1/2	3	1.09	26.46
PLATE RACK	ITEM	Description	L(in.)	W(in.)	H(in.)	Cubic Feet (ft <sup>3</sup> )/CTN	lb/CTN
	<b>PR3015</b>	Wall - Plate Rack - 30"W x 15"H x 12"D	31 3/4	17 1/4	6 3/4	2.10	24.03
GLASS HOLDER	ITEM	Description	L(in.)	W(in.)	H(in.)	Cubic Feet (ft <sup>3</sup> )/CTN	lb/CTN
	<b>GL30</b>	Wall - Glass Holder - 30"W x 1-1/2"H x 12"D	31 1/4	14 1/4	2	0.51	5.84
	<b>GL36</b>	Wall - Glass Holder - 36"W x 1-1/2"H x 12"D	37 1/2	14 1/4	2	0.60	7.05

GLASS DOOR	ITEM	Description	L(in.)	W(in.)	H(in.)	Cubic Feet (ft <sup>3</sup> ) /CTN	lb/CTN
	GDW1230	Glass Door - 12"W x 30"H	31 1/4	13 3/4	1 1/2	0.34	7.61
	GDW1530	Glass Door - 15"W x 30"H	31 1/4	16 3/4	1 1/2	0.42	9.26
	GDW1830	Glass Door - 18"W x 30"H	31 1/4	19 3/4	1 1/2	0.49	11.46
	GDW2130	Glass Door - 21"W x 30"H	31 1/4	22 3/4	1 1/2	0.57	13.01
	GDW2430	Glass Door - 24"W x 30"H	31 1/4	13 3/4	2 1/4	0.57	14.33
	GDW2730	Glass Door - 27"W x 30"H	31 1/4	15 1/4	2 1/4	0.64	15.43
	GDW3030	Glass Door - 30"W x 30"H	31 1/4	17	2 1/4	0.70	17.42
	GDW3330	Glass Door - 33"W x 30"H	31 1/4	18 1/4	2 1/4	0.76	19.18
	GDW3630	Glass Door - 36"W x 30"H	31 1/4	20	2 1/4	0.82	22.49
	GDWDC2430	Glass Door - WDC2430	31 1/4	16	1 1/2	0.40	18.08
	GDW1236	Glass Door - 12"W x 36"H	37 1/4	13 3/4	1 1/2	0.41	8.82
	GDW1536	Glass Door - 15"W x 36"H	37 1/4	16 3/4	1 1/2	0.50	10.58
	GDW1836	Glass Door - 18"W x 36"H	37 1/4	19 3/4	1 1/2	0.58	12.79
	GDW2136	Glass Door - 21"W x 36"H	37 1/4	22 3/4	1 1/2	0.67	14.33
	GDW2436	Glass Door - 24"W x 36"H	37 1/4	13 3/4	2 1/4	0.68	15.65
	GDW2736	Glass Door - 27"W x 36"H	37 1/4	15 1/2	2 1/4	0.76	18.30
	GDW3036	Glass Door - 30"W x 36"H	37 1/4	17	2 1/4	0.83	20.28
	GDW3336	Glass Door - 33"W x 36"H	37 1/4	18 1/4	2 1/4	0.90	22.05
	GDW3636	Glass Door - 36"W x 36"H	37 1/4	20	2 1/4	0.98	25.57
	GDWDC2436	Glass Door - WDC2436	37 1/4	16	1 1/2	0.47	21.16
	GDW1242	Glass Door - 12"W x 42"H	43 1/4	13 3/4	1 1/2	0.48	9.92
	GDW1542	Glass Door - 15"W x 42"H	43 1/4	16 3/4	1 1/2	0.58	11.90
	GDW1842	Glass Door - 18"W x 42"H	43 1/4	19 3/4	1 1/2	0.68	14.77
	GDW2142	Glass Door - 21"W x 42"H	43 1/4	22 3/4	1 1/2	0.78	17.64
	GDW2442	Glass Door - 24"W x 42"H	43 1/4	13 3/4	2 1/4	0.79	20.28
	GDW2742	Glass Door - 27"W x 42"H	43 1/4	15 1/4	2 1/4	0.88	21.38
	GDW3042	Glass Door - 30"W x 42"H	43 1/4	17	2 1/4	0.97	23.59
	GDW3342	Glass Door - 33"W x 42"H	43 1/4	18 1/4	2 1/4	1.05	25.90
	GDW3642	Glass Door - 36"W x 42"H	43 1/4	20	2 1/4	1.14	28.44
	GDWDC2442	Glass Door - WDC2442	43 1/4	16	1 1/2	0.55	23.81
	GDW1215	Glass Door - 12"W x 15"H	16 1/4	13 3/4	1 1/2	0.18	1.98
	GDW1515	Glass Door - 15"W x 15"H	16 1/4	16 3/4	1 1/2	0.22	3.75
	GDW1815	Glass Door - 18"W x 15"H	19 1/4	16 3/4	1 1/2	0.26	5.95
	GDW2115	Glass Door - 21"W x 15"H	22 1/4	16 3/4	1 1/2	0.30	7.50
	GDW2415	Glass Door - 24"W x 15"H	16 1/4	13 3/4	2 1/4	0.30	8.82
	GDW2715	Glass Door - 27"W x 15"H	16 1/4	15 1/4	2 1/4	0.33	11.46
	GDW3015	Glass Door - 30"W x 15"H	16 1/2	16 3/4	2 1/4	0.37	13.45
	GDW3315	Glass Door - 33"W x 15"H	18	16 3/4	2 1/4	0.40	15.21
	GDW3615	Glass Door - 36"W x 15"H	19 1/2	16 3/4	2 1/4	0.43	18.74
	GDWDC2415	Glass Door - WDC2415	16 1/4	16	1 1/2	0.21	6.17
	GDW1218	Glass Door - 12"W x 18"H	19 1/4	13 3/4	1 1/2	0.21	3.31
	GDW1518	Glass Door - 15"W x 18"H	19 1/4	16 3/4	1 1/2	0.26	5.29
	GDW1818	Glass Door - 18"W x 18"H	19 1/4	19 3/4	1 1/2	0.30	8.16
	GDW2118	Glass Door - 21"W x 18"H	22 1/4	19 3/4	1 1/2	0.35	11.02
	GDW2418	Glass Door - 24"W x 18"H	19 1/4	13 3/4	2 1/4	0.35	13.67
	GDW2718	Glass Door - 27"W x 18"H	19 1/4	15 1/4	2 1/4	0.39	14.77
	GDW3018	Glass Door - 30"W x 18"H	19 1/4	17	2 1/4	0.43	16.98
	GDW3318	Glass Door - 33"W x 18"H	19 1/4	18 1/4	2 1/4	0.47	19.29
	GDW3618	Glass Door - 36"W x 18"H	19 1/2	19 3/4	2 1/4	0.51	21.83
	GDWDC2418	Glass Door - WDC2418	19 1/4	16	1 1/2	0.25	8.82

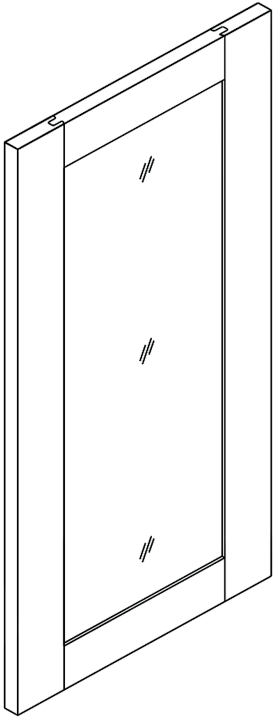

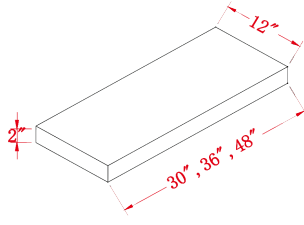
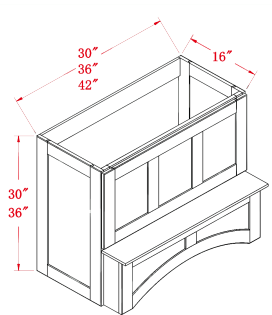
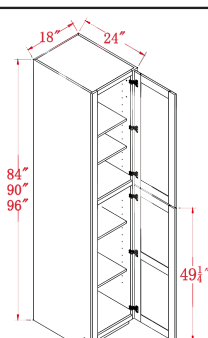
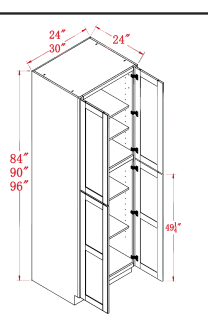

FLOATING SHELF	ITEM	Description	L(in.)	W(in.)	H(in.)	Cubic Feet (ft <sup>3</sup> ) /CTN	lb/CTN
	<b>FLS30</b>	Flat Shelf 30"W x 2"H x 12"D	31 1/2	14	2 3/4	0.70	10.25
	<b>FLS36</b>	Flat Shelf 36"W x 2"H x 12"D	37 1/4	14	2 3/4	0.83	12.35
	<b>FLS48</b>	Flat Shelf 48"W x 2"H x 12"D	49 1/2	14	2 3/4	1.10	14.99
WOOD HOOD	ITEM	Description	L(in.)	W(in.)	H(in.)	Cubic Feet (ft <sup>3</sup> ) /CTN	lb/CTN
	<b>RHA3030</b>	Wall - Wood Range Hood - 30"W x 30"H x 22"D					
	<b>RHA3630</b>	Wall - Wood Range Hood - 36"W x 30"H x 22"D					
	<b>RHA4230</b>	Wall - Wood Range Hood - 42"W x 30"H x 22"D					
	<b>RHA4236</b>	Wall - Wood Range Hood - 42"W x 36"H x 22"D					
PANTRY CABINETS 24" DEEP	ITEM	Description	L(in.)	W(in.)	H(in.)	Cubic Feet (ft <sup>3</sup> ) /CTN	lb/CTN
	<b>TP1884</b>	Tall - Shelf Pantry w/ 2 Door & 5 Shelf - 18"W x 84"H x 24"D	86	26 1/4	5	6.41	116.29
	<b>TP1890</b>	Tall - Shelf Pantry w/ 2 Door & 5 Shelf - 18"W x 90"H x 24"D	92	26 1/4	5	6.85	124.34
	<b>TP1896</b>	Tall - Shelf Pantry w/ 2 Door & 6 Shelf - 18"W x 96"H x 24"D	97 3/4	26 1/4	5	7.29	135.25
PANTRY CABINETS 24" DEEP	ITEM	Description	L(in.)	W(in.)	H(in.)	Cubic Feet (ft <sup>3</sup> ) /CTN	lb/CTN
	<b>TP2484</b>	Tall - Shelf Pantry w/ 4 Door & 5 Shelf - 24"W x 84"H x 24"D	86	26 1/4	5	6.41	142.20
	<b>TP2490</b>	Tall - Shelf Pantry w/ 4 Door & 5 Shelf - 24"W x 90"H x 24"D	92	26 1/4	5	6.85	157.52
	<b>TP2496</b>	Tall - Shelf Pantry w/ 4 Door & 6 Shelf - 24"W x 96"H x 24"D	97 3/4	26 1/4	5	7.29	167.77
	<b>TP3084</b>	Tall - Shelf Pantry w/ 4 Door & 5 Shelf - 30"W x 84"H x 24"D	86	32 1/2	5	7.96	168.21
	<b>TP3090</b>	Tall - Shelf Pantry w/ 4 Door & 5 Shelf - 30"W x 90"H x 24"D	92	32 1/2	5	8.50	181.00
	<b>TP3096</b>	Tall - Shelf Pantry w/ 4 Door & 5 Shelf - 30"W x 96"H x 24"D	97 3/4	32 1/5	5	9.05	194.45

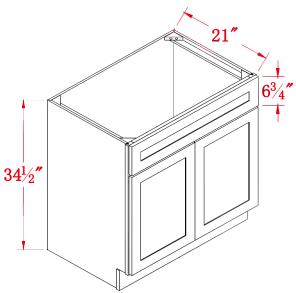
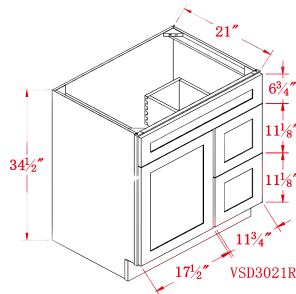
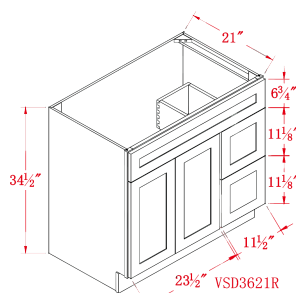
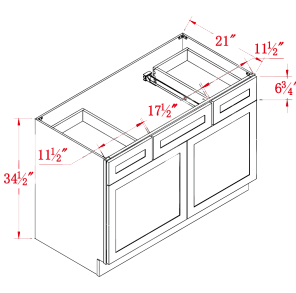
OVEN CABINETS	ITEM	Description	L(in.)	W(in.)	H(in.)	Cubic Feet (ft <sup>3</sup> ) /CTN	lb/CTN
	<b>OC3384</b>	Appliance Tall - Oven Shelf w/ 2 Door & 3 Drawer - 33"W x 84"H x 24"D	86	35 3/4	5	9.08	206.02
	<b>OC3390</b>	Appliance Tall - Oven Shelf w/ 2 Door & 3 Drawer - 33"W x 90"H x 24"D	92	35 3/4	5	9.70	211.53
	<b>OC3396</b>	Appliance Tall - Oven Shelf w/ 2 Door & 3 Drawer - 33"W x 96"H x 24"D	97 3/4	35 3/4	5	10.32	225.97
VANITY BASE 21" DEEP	ITEM	Description	L(in.)	W(in.)	H(in.)	Cubic Feet (ft <sup>3</sup> ) /CTN	lb/CTN
	<b>VB1221</b>	Vanity Base - 1 Door & 1 Drawer - 12"W x 34-1/2"H x 21"D	36 1/4	22 1/2	5	2.41	46.08
	<b>VB1521</b>	Vanity Base - 1 Door & 1 Drawer - 15"W x 34-1/2"H x 21"D	36 1/4	22 1/2	5	2.41	49.71
	<b>VB1821</b>	Vanity Base - 1 Door & 1 Drawer - 18"W x 34-1/2"H x 21"D	36 1/4	22 1/2	4	1.85	54.01
	<b>VB2121</b>	Vanity Base - 1 Door & 1 Drawer - 21"W x 34-1/2"H x 21"D	39	22 1/2	4	1.99	57.87
VANITY BASE 21" DEEP	ITEM	Description	L(in.)	W(in.)	H(in.)	Cubic Feet (ft <sup>3</sup> ) /CTN	lb/CTN
	<b>VB2421</b>	Vanity Base - 2 Door & 1 Drawer - 24"W x 34-1/2"H x 21"D	39	22 1/2	4	2.41	46.08
	<b>VB2721</b>	Vanity Base - 2 Door & 1 Drawer - 27"W x 34-1/2"H x 21"D	39	29	4	2.85	73.74
	<b>VB3021</b>	Vanity Base - 2 Door & 1 Drawer - 30"W x 34-1/2"H x 21"D	39	32	4	2.85	73.74
	<b>VB3321</b>	Vanity Base - 2 Door & 1 Drawer - 33"W x 34-1/2"H x 21"D	36 1/4	32	4	2.65	77.60
	<b>VB3621</b>	Vanity Base - 2 Door & 1 Drawer - 36"W x 34-1/2"H x 21"D	37 3/4	32	4	2.76	82.56
VANITY DRAWERS BASE 21" DEEP	ITEM	Description	L(in.)	W(in.)	H(in.)	Cubic Feet (ft <sup>3</sup> ) /CTN	lb/CTN
	<b>VDB1221</b>	Vanity Drawer Base - 3 Drawer - 12"W x 34-1/2"H x 21"D	36 1/4	22 1/2	6	2.78	67.68
	<b>VDB1521</b>	Vanity Drawer Base - 3 Drawer - 15"W x 34-1/2"H x 21"D	36 1/4	22 1/2	6 1/4	2.96	72.86
	<b>VDB1821</b>	Vanity Drawer Base - 3 Drawer - 18"W x 34-1/2"H x 21"D	36 1/4	22 1/2	6 1/4	2.96	79.15
	<b>VDB2121</b>	Vanity Drawer Base - 3 Drawer - 21"W x 34-1/2"H x 21"D	37 3/4	26 1/4	6	3.49	84.22
	<b>VDB2421</b>	Vanity Drawer Base - 3 Drawer - 24"W x 34-1/2"H x 21"D	37 3/4	29	6 1/4	3.86	92.04
	<b>VDB2721</b>	Vanity Drawer Base - 3 Drawer - 27"W x 34-1/2"H x 21"D	37 3/4	31	6 1/4	4.26	99.32
	<b>VDB3021</b>	Vanity Drawer Base - 3 Drawer - 30"W x 34-1/2"H x 21"D	36 3/4	32	6 1/4	4.24	107.14
	<b>VDB3321</b>	Vanity Drawer Base - 3 Drawer - 33"W x 34-1/2"H x 21"D	36 1/4	32	6 1/4	4.24	110.34
	<b>VDB3621</b>	Vanity Drawer Base - 3 Drawer - 36"W x 34-1/2"H x 21"D	37 3/4	32	6 1/4	4.42	117.95

VANITY SINK BASE 21" DEEP		ITEM	Description	L(in.)	W(in.)	H(in.)	Cubic Feet (ft <sup>3</sup> ) /CTN	lb/CTN
	<b>VSB2421</b>	Vanity Sink Base - 2 Door & 1 False Drawer - 24"W x 34-1/2"H x 21"D	36 1/4	26	4 1/2	2.36	44.86	
	<b>VSB2721</b>	Vanity Sink Base - 2 Door & 1 False Drawer - 27"W x 34-1/2"H x 21"D	36 1/4	29	4 1/2	2.63	48.72	
	<b>VSB3021</b>	Vanity Sink Base - 2 Door & 1 False Drawer - 30"W x 34-1/2"H x 21"D	36 1/4	32	4 1/2	2.91	52.14	
	<b>VSB3321</b>	Vanity Sink Base - 2 Door & 1 False Drawer - 33"W x 34-1/2"H x 21"D	36 1/4	32	4 1/2	2.91	56.44	
	<b>VSB3621</b>	Vanity Sink Base - 2 Door & 1 False Drawer - 36"W x 34-1/2"H x 21"D	37 3/4	32	4 1/2	3.04	58.97	
VANITY SINK DRAWER BASE 21" DEEP		ITEM	Description	L(in.)	W(in.)	H(in.)	Cubic Feet (ft <sup>3</sup> ) /CTN	lb/CTN
	<b>VSD3021L</b>	Vanity Sink Drawer Base - 2 Door & 2 Left Drawer - 30"W x 34-1/2"H x 21"D	36 1/4	32	5	3.44	77.16	
	<b>VSD3021R</b>	Vanity Sink Drawer Base - 2 Door & 2 Right Drawer - 30"W x 34-1/2"H x 21"D	36 1/4	32	5	3.44	77.93	
VANITY SINK DRAWER BASE 21" DEEP		ITEM	Description	L(in.)	W(in.)	H(in.)	Cubic Feet (ft <sup>3</sup> ) /CTN	lb/CTN
	<b>VSD3621L</b>	Vanity Sink Drawer base - 2 Door & 2 Left Drawer - 36"W x 34-1/2"H x 21"D	37 3/4	32	5	3.59	73.19	
	<b>VSD3621R</b>	Vanity Sink Drawer base - 2 Door & 2 Right Drawer - 36"W x 34-1/2"H x 21"D	37 3/4	32	5	3.59	74.08	
VANITY SINK DRAWER BASE 21" DEEP		ITEM	Description	L(in.)	W(in.)	H(in.)	Cubic Feet (ft <sup>3</sup> ) /CTN	lb/CTN
	<b>VSD4221</b>	Vanity Sink Drawer Base - 2 Door, 2 Drawer & False Drawer - 42"W x 34-1/2"H x 21"D	43 3/4	32	5	4.15	85.43	

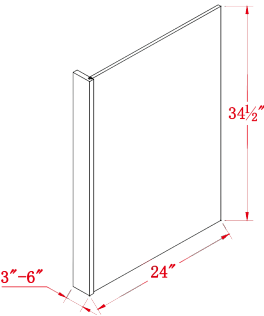
VANITY SINK DRAWER BASE 21" DEEP	ITEM	Description	L(in.)	W(in.)	H(in.)	Cubic Feet (ft <sup>3</sup> ) /CTN	lb/CTN
	<b>VSD4821</b>	Vanity Sink Drawer Base - 2 Door, 4 Drawer & False Drawer - 48"W x 34-1/2"H x 21"D	50 1/4	32	5	4.77	127.32
VANITY SINK DRAWER SINGLE	ITEM	Description	L(in.)	W(in.)	H(in.)	Cubic Feet (ft <sup>3</sup> ) /CTN	lb/CTN
	<b>VSD60SINGLE</b>	Vanity Sink Drawer Base - 2 Door, 6 Drawer & False Drawer - 60"W x 34-1/2"H x 21"D	61 3/4	32	5	5.87	166.34
VANITY SINK DRAWER DOUBLE	ITEM	Description	L(in.)	W(in.)	H(in.)	Cubic Feet (ft <sup>3</sup> ) /CTN	lb/CTN
	<b>VSD60DOUBLE</b>	Vanity Sink Drawer Base - 4 Door, 3 Drawer & 2 False Drawer - 60"W x 34-1/2"H x 21"D	61 3/4	32	5	5.87	126.66
KNEE DRAWER	ITEM	Description	L(in.)	W(in.)	H(in.)	Cubic Feet (ft <sup>3</sup> ) /CTN	lb/CTN
	<b>KD30</b>	Knee Drawer - 30"W x 7-3/16"H x 21"D	31 3/4	19	2 3/4	0.97	23.26

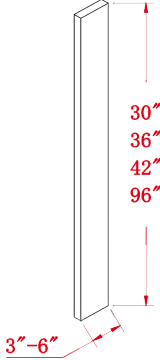
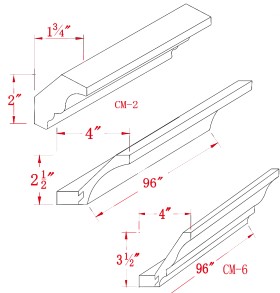
DISHWASHER PANEL	ITEM	Description	L(in.)	W(in.)	H(in.)	Cubic Feet (ft <sup>3</sup> ) /CTN	lb/CTN
	<b>DWR3</b>	Dishwasher Return Panel w/ 3" Filler - 24"W x 34-1/2"H x 1/2"D	35 3/4	25 1/2	1 3/4	0.93	8.80
	<b>DWR6</b>	Dishwasher Return Panel w/ 6" Filler - 24"W x 34-1/2"H x 1/2"D	35 3/4	25 1/2	4 3/4	2.49	9.59
BASE FILLER	ITEM	Description	L(in.)	W(in.)	H(in.)	Cubic Feet (ft <sup>3</sup> ) /CTN	lb/CTN
	<b>BF3</b>	Base Filler 3" 03"W x 34-1/2"H x 3/4"D	38 1/4	8 1/4	3 3/4	0.68	12.13
	<b>BF6</b>	Base Filler 6" 06"W x 34-1/2"H x 3/4"D	38 1/4	8 1/4	6 3/4	1.22	4.29
WALL FILLER	ITEM	Description	L(in.)	W(in.)	H(in.)	Cubic Feet (ft <sup>3</sup> ) /CTN	lb/CTN
	<b>WF330</b>	Wall Filler 3" - 03"W x 30"H x 3/4"D	31 1/2	5 3/4	3 1/2	0.37	1.54
	<b>WF336</b>	Wall Filler 3" - 03"W x 36"H x 3/4"D	37 1/2	5 3/4	3 1/2	0.44	1.76
	<b>WF342</b>	Wall Filler 3" - 03"W x 42"H x 3/4"D	43 1/4	5 3/4	3 1/2	0.51	1.98
	<b>WF396</b>	Wall Filler 3" - 03"W x 96"H x 3/4"D	97 1/2	5 3/4	3 1/2	1.14	22.27
	<b>WF630</b>	Wall Filler 6" - 06"W x 30"H x 3/4"D	31 1/2	7 3/4	4 1/4	0.62	2.29
	<b>WF636</b>	Wall Filler 6" - 06"W x 36"H x 3/4"D	37 1/2	7 3/4	4 1/4	0.74	3.53
	<b>WF642</b>	Wall Filler 6" - 06"W x 42"H x 3/4"D	43 1/4	7 3/4	4 1/4	0.85	3.53
	<b>WF696</b>	Wall Filler 6" - 06"W x 96"H x 3/4"D	97 1/2	8 1/2	4 3/4	2.28	42.77
CROWN MOLDING	ITEM	Description	L(in.)	W(in.)	H(in.)	Cubic Feet (ft <sup>3</sup> ) /CTN	lb/CTN
	<b>CM2</b>	Crown Molding - 96"W x 2"H x 1-3/4"D					
	<b>CM4</b>	Crown Molding - 96"W x 2-1/2"H x 2-1/2"D	97 1/2	5 3/4	4 1/2	1.46	1.87
	<b>CM6</b>	Crown Molding - 96"W x 3-1/2"H x 2-1/2"D	97 1/2	6	4 1/2	1.56	21.94

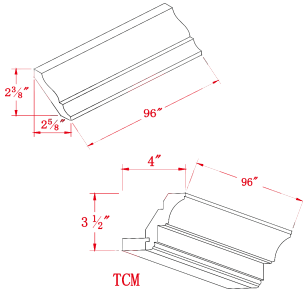
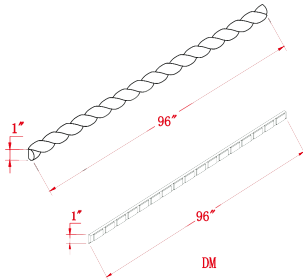
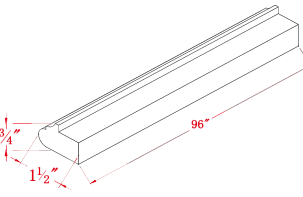
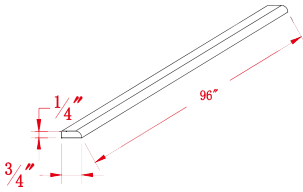
CROWN MOLDING	ITEM	Description	L(in.)	W(in.)	H(in.)	Cubic Feet (ft <sup>3</sup> ) /CTN	lb/CTN
	<b>CM1</b>	Crown Molding - 96"W x 2-5/8"H x 2-3/8"D	97 1/2	5 1/2	4 1/4	1.35	3.33
	<b>TCM</b>	Crown Molding - 96"W x 3-1/2"H x 04"D	97 1/2	7 1/2	6	2.49	7.43
DECORATIVE MOLDING	ITEM	Description	L(in.)	W(in.)	H(in.)	Cubic Feet (ft <sup>3</sup> ) /CTN	lb/CTN
	<b>RM</b>	Rope Molding - 96"W x 01"H x 3/8"D					0.49
	<b>DM</b>	Dentil Molding - 96"W x 01"H x 3/8"D					0.46
LIGHT RAIL MOLDING	ITEM	Description	L(in.)	W(in.)	H(in.)	Cubic Feet (ft <sup>3</sup> ) /CTN	lb/CTN
	<b>LRM</b>	Light Rail Molding - 96"W x 1-1/2"H x 3/4"D	97 1/2	6 3/4	2 1/4	0.82	0.85
SCRIBE MOLDING	ITEM	Description	L(in.)	W(in.)	H(in.)	Cubic Feet (ft <sup>3</sup> ) /CTN	lb/CTN
	<b>SM8-5</b>	Scribe Molding - 96"W x 3/4"H x 1/4"D	97 1/2	5 3/4	2 1/4	0.70	9.26



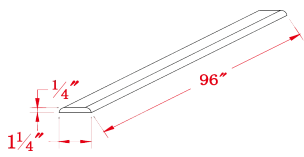
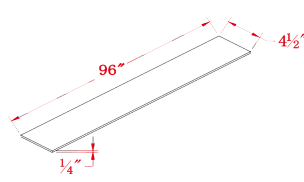
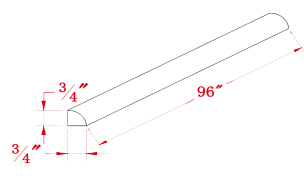
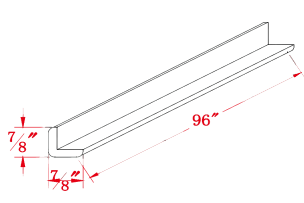

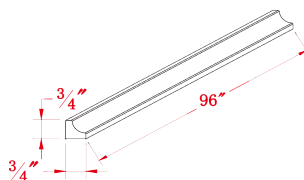
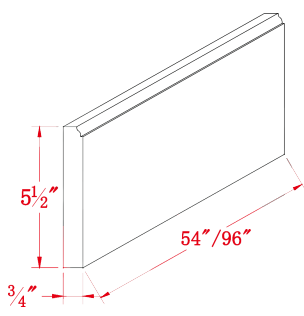
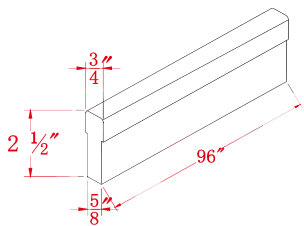
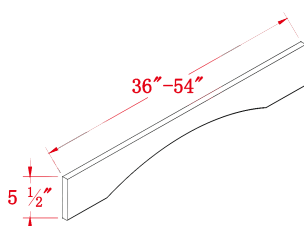
BATTEN MOLDING	ITEM	Description	L(in.)	W(in.)	H(in.)	Cubic Feet (ft <sup>3</sup> ) /CTN	lb/CTN
	<b>BM1-1/4</b>	Batten Molding - 96"W x 1-1/4"H x 1/4"D	97 1/2	8 1/2	2 1/4	1.03	1.76
TOE KICK	ITEM	Description	L(in.)	W(in.)	H(in.)	Cubic Feet (ft <sup>3</sup> ) /CTN	lb/CTN
	<b>TK8</b>	Toe Kick Plate - 96"W x 4-1/2"H x 1/4"D	97 1/2	6 1/2	5	1.87	1.76
QUARTER ROUND MOLDING	ITEM	Description	L(in.)	W(in.)	H(in.)	Cubic Feet (ft <sup>3</sup> ) /CTN	lb/CTN
	<b>QRM</b>	Shoe Molding - 96"W x 3/4"H x 3/4"D	97 1/2	5 1/4	4 1/4	1.30	0.71
OUTSIDE CORNER MOLDING	ITEM	Description	L(in.)	W(in.)	H(in.)	Cubic Feet (ft <sup>3</sup> ) /CTN	lb/CTN
	<b>OCM8</b>	Outside Corner Molding - 96"W x 7/8"H x 7/8"D	97 1/2	7 3/4	2 3/4	1.19	0.66

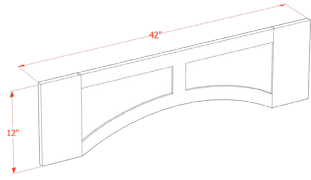
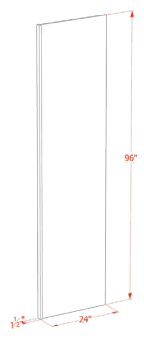
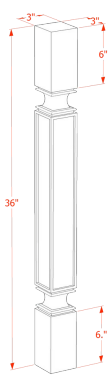
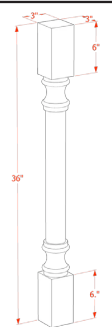
INSIDE CORNER MOLDING	ITEM	Description	L(in.)	W(in.)	H(in.)	Cubic Feet (ft <sup>3</sup> ) /CTN	lb/CTN
	<b>ICM8</b>	Inside Molding - 96"W x 3/4"H x 3/4"D	97 1/2	6	5	1.76	0.35
BASEBOARD MOLDING	ITEM	Description	L(in.)	W(in.)	H(in.)	Cubic Feet (ft <sup>3</sup> ) /CTN	lb/CTN
	<b>VST96</b>	Baseboard Molding - 96"W x 5 1/2"H x 3/4"D	97 3/4	7 1/4	4 1/4	1.78	5.38
STACKING MOLDING	ITEM	Description	L(in.)	W(in.)	H(in.)	Cubic Feet (ft <sup>3</sup> ) /CTN	lb/CTN
	<b>STKM8</b>	Stacking Molding 96"W x 2-1/2"H x 3/4"D-5/8"D	97 3/4	7	4 1/4	1.69	2.34
VALANCE	ITEM	Description	L(in.)	W(in.)	H(in.)	Cubic Feet (ft <sup>3</sup> ) /CTN	lb/CTN
	<b>VAR36</b>	Valance - 36"W x 5 1/2"H x 3/4"D	37 1/2	7 1/4	4 1/4	0.68	2.65
	<b>VAR54</b>	Valance - 54"W x 5 1/2"H x 3/4"D	55 1/4	7/4	4 1/4	1.01	3.68

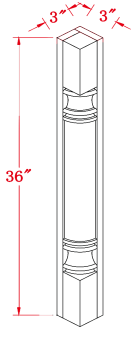
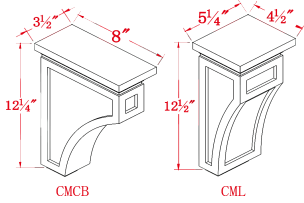
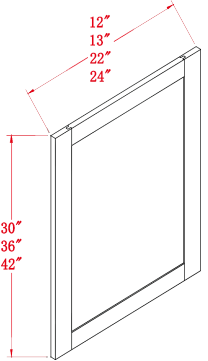
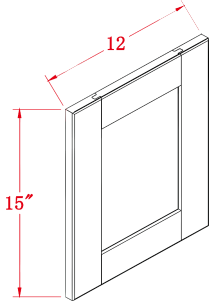
VALANCE	ITEM	Description	L(in.)	W(in.)	H(in.)	Cubic Feet (ft <sup>3</sup> ) /CTN	lb/CTN
	<b>VARP42</b>	Valance w/ Raised Panel 42" Trimable to 36" - 42"W x 12"H x 3/4"D	43 3/4	14 1/4	1 1/2	0.49	7.72
	<b>VARP54</b>	Valance w/ Raised Panel 54" Trimable to 48" - 54"W x 12"H x 3/4"D	55 3/4	14 1/4	1 1/2	0.63	9.26
REFRIGERATOR END PANEL	ITEM	Description	L(in.)	W(in.)	H(in.)	Cubic Feet (ft <sup>3</sup> ) /CTN	lb/CTN
	<b>REP2496</b>	Refrigerator End Panel - 24"W x 96"H x 1-1/2"D	97 1/2	6 1/2	5	1.87	1.76
POST	ITEM	Description	L(in.)	W(in.)	H(in.)	Cubic Feet (ft <sup>3</sup> ) /CTN	lb/CTN
	<b>SP336</b>	Square Roman Pillar - 03"W x 36"H x 03"D	37 1/2	8	3 1/4	0.58	4.19
POST	ITEM	Description	L(in.)	W(in.)	H(in.)	Cubic Feet (ft <sup>3</sup> ) /CTN	lb/CTN
	<b>RP336</b>	Round Roman Pillar - 03"W x 36"H x 03"D	37 3/4	7 3/4	3 1/4	0.56	3.64
	<b>RP436</b>	Round Roman Pillar - 04"W x 36"H x 04"D	37 3/4	10 3/4	5	1.17	6.72

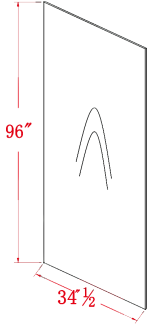
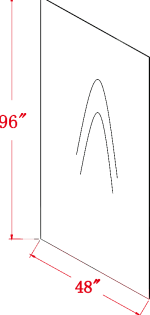
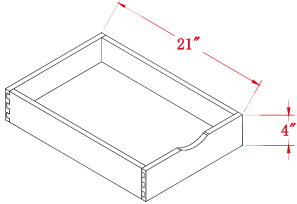
POST	ITEM	Description	L(in.)	W(in.)	H(in.)	Cubic Feet (ft <sup>3</sup> ) /CTN	lb/CTN
	<b>CP36</b>	Corner Roman Pillar - 03"W x 36"H x 03"D	37 3/4	7 3/4	3 1/4	0.56	4.08
CORBELS	ITEM	Description	L(in.)	W(in.)	H(in.)	Cubic Feet (ft <sup>3</sup> ) /CTN	lb/CTN
	<b>CMCB</b>	Corbel - 3-1/2"W x 12-1/4"H x 08"D	13 1/2	9 3/4	4	0.30	3.31
	<b>CML</b>	Corbel - 5-1/4"W x 12-1/2"H x 4-1/2"D	14	7 1/4	5 1/4	0.31	3.17
WAINSCOT PANEL	ITEM	Description	L(in.)	W(in.)	H(in.)	Cubic Feet (ft <sup>3</sup> ) /CTN	lb/CTN
	<b>WP-BASE</b>	Wainscot Panel Base - 23-1/2"W x 29-1/2"H x 3/4"D	31 1/2	26	1 1/2	0.66	11.02
	<b>WP-W30</b>	Wainscot Panel Base - 11-1/2"W x 29-1/2"H x 3/4"D	31 3/4	14	1 1/2	0.36	6.61
	<b>WP-W36</b>	Wainscot Panel Base - 11-1/2"W x 35-1/2"H x 3/4"D	37 3/4	14	1 1/2	0.42	7.05
	<b>WP-W42</b>	Wainscot Panel Base - 11-1/2"W x 41-1/2"H x 3/4"D	43 3/4	14	1 1/2	0.49	7.50
SAMPLE DOOR	ITEM	Description	L(in.)	W(in.)	H(in.)	Cubic Feet (ft <sup>3</sup> ) /CTN	lb/CTN
	<b>SD</b>	Sample Door - 12"W x 15"H x 3/4"D	16 3/4	14 1/4	4 1/4	0.59	14.33

BASE END SKIN PANEL	ITEM	Description	L(in.)	W(in.)	H(in.)	Cubic Feet (ft <sup>3</sup> ) /CTN	lb/CTN
	<b>BP-3496-1/4</b>	End Skin Panel (Plywood) - 34-1/2"W x 96"H x 1/4"D	97 1/2	36 1/2	1 1/2	2.84	17.86
BASE END SKIN PANEL	ITEM	Description	L(in.)	W(in.)	H(in.)	Cubic Feet (ft <sup>3</sup> ) /CTN	lb/CTN
	<b>BP4896-1/4</b>	End Skin Panel - 48"W x 96"H x 1/4"D	97 1/2	50 1/4	1 1/2	3.90	24.47
	<b>BP4896-1/2</b>	End Skin Panel - 48"W x 96"H x 1/2"D	97 1/2	50 1/4	1 1/4	3.34	55.12
	<b>BP4896-3/4</b>	End Skin Panel - 48"W x 96"H x 3/4"D	97 1/2	50 1/4	1 1/4	3.34	6614
	<b>BP2496-3/4</b>	End Skin Panel - 24"W x 96"H x 3/4"D					
ROLL OUT TRAY	ITEM	Description	L(in.)	W(in.)	H(in.)	Cubic Feet (ft <sup>3</sup> ) /CTN	lb/CTN
	<b>RD15</b>	Roll Out Tray - 15" Drawer Box	25	12	2	0.34	10.19
	<b>RD18</b>	Roll Out Tray - 18" Drawer Box	25	15 1/4	2	0.43	11.18
	<b>RD21</b>	Roll Out Tray - 21" Drawer Box	25	18	2	0.51	11.90
	<b>RD24</b>	Roll Out Tray - 24" Drawer Box	25	21	2	0.60	13.05
	<b>RD27</b>	Roll Out Tray - 27" Drawer Box	26 1/2	22	2	0.67	14.09
	<b>RD30</b>	Roll Out Tray - 30" Drawer Box	29 1/4	22	2	0.74	15.17
	<b>RD33</b>	Roll Out Tray - 33" Drawer Box	32 1/2	22	2	0.82	15.70
	<b>RD36</b>	Roll Out Tray - 36" Drawer Box	35 1/2	22	2	0.89	17.06
TOUCH UP KIT	ITEM	Description	L(in.)	W(in.)	H(in.)	Cubic Feet (ft <sup>3</sup> ) /CTN	lb/CTN
	<b>TOUCH</b>	Touch Up Kit					